

ELGAR

MODELS 251 & 501A

AC Power Sources

Instruction Manual

ELGAR ELECTRONICS CORPORATION

9250 Brown Deer Road
San Diego, CA 92121-2294
1-800-733-5427
Tel: (858) 450-0085
Fax: (858) 458-0267
Email: sales@elgar.com
www.elgar.com

©1983 by Elgar Electronics Corporation

This document contains information proprietary to Elgar Electronics Corporation. The information contained herein is not to be duplicated or transferred in any manner without prior written permission from Elgar Electronics Corporation.

October 1983

Document No. 104-1PH-26

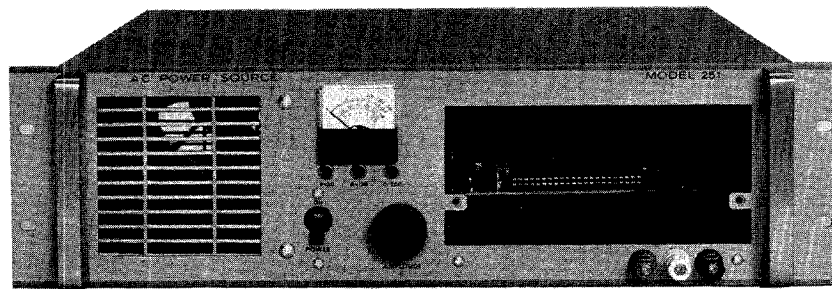
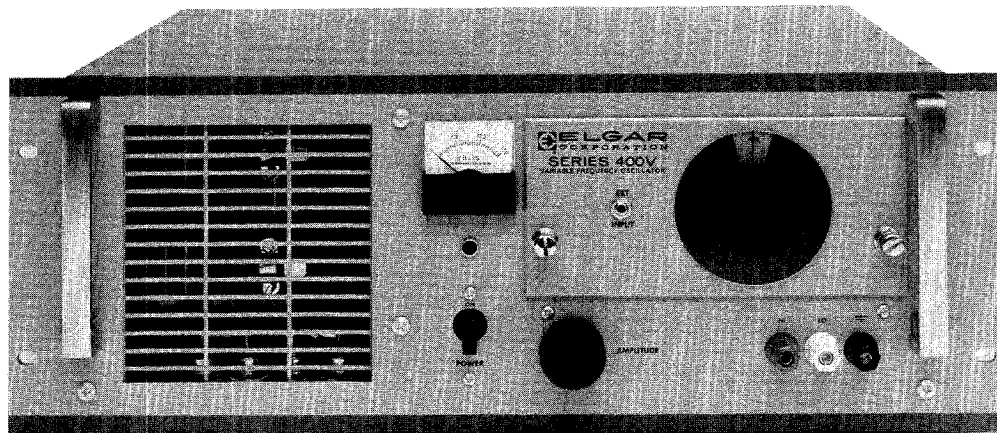

**MODELS 251 & 501A
AC POWER SOURCES**

ELGAR ONE-YEAR WARRANTY

Elgar Electronics Corporation (hereinafter referred to as Elgar) warrants its products to be free from defects in material and workmanship. This warranty is effective for one year from the date of shipment of the product to the original purchaser. Liability of Elgar under this warranty shall exist provided that:

- the Buyer exposes the product to normal use and service and provides normal maintenance on the product;
- Elgar is promptly notified of defects by the Buyer and that notification occurs within the warranty period;
- the Buyer receives a Return Material Authorization (RMA) number from Elgar's Repair Department prior to the return of the product to Elgar for repair, phone 800-73-ELGAR (800-733-5427), ext. 2295;
- the Buyer returns the defective product in the original, or equivalent, shipping container;
- if, upon examination of such product by Elgar it is disclosed that, in fact, a defect in materials and/or workmanship does exist, that the defect in the product was not caused by improper conditions, misuse, or negligence; and,
- that Elgar QA seal and nameplates have not been altered or removed and the equipment has not been repaired or modified by anyone other than Elgar authorized personnel.

This warranty is exclusive and in lieu of all other warranties, expressed or implied, including, but not limited to, implied warranties of merchantability and fitness of the product to a particular purpose. Elgar, its agents, or representatives shall in no circumstance be liable for any direct, indirect, special, penal, or consequential loss or damage of any nature resulting from the malfunction of the product. Remedies under this warranty are expressly limited to repair or replacement of the product.

CONDITIONS OF WARRANTY

- To return a defective product, contact an Elgar representative or the Elgar factory for an RMA number. Unauthorized returns will not be accepted and will be returned at the shipper's expense.
- For Elgar products found to be defective within thirty days of receipt by the original purchaser, Elgar will absorb all ground freight charges for the repair. Products found defective within the warranty period, but beyond the initial thirty-day period, should be returned prepaid to Elgar for repair. Elgar will repair the unit and return it by ground freight pre-paid.
- Normal warranty service is performed at Elgar during the weekday hours of 7:30 am to 4:30 pm Pacific time. Warranty repair work requested to be accomplished outside of normal working hours will be subject to Elgar non-warranty service rates.
- Warranty field service is available on an emergency basis. Travel expenses (travel time, per diem expense, and related air fare) are the responsibility of the Buyer. A Buyer purchase order is required by Elgar prior to scheduling.
- A returned product found, upon inspection by Elgar, to be in specification is subject to an inspection fee and applicable freight charges.
- Equipment purchased in the United States carries only a United States warranty for which repair must be accomplished at the Elgar factory.

ELGAR

Committed to Quality...Striving for Excellence

TABLE OF CONTENTS

**SECTION I
GENERAL DESCRIPTION**

1-1	Introduction	1-1
1-3	General Description	1-1
1-9	Physical Description	1-1
1-14	Performance Specifications	1-2
1-16	System Applications	1-2

**SECTION II
INSTALLATION**

2-1	Introduction	2-1
2-3	Unpacking and Receiving Inspection	2-1
2-5	Rack Mounting	2-1
2-8	Installation	2-2
2-17	Checkout	2-2

**SECTION III
OPERATION**

3-1	Introduction	3-1
3-3	Controls and Indicators	3-1

**SECTION IV
THEORY OF OPERATION**

4-1	Circuit Description	4-1
4-6	Power Supplies	4-1
4-8	Interconnections for Multi-Phase Operation	4-5

**SECTION V
MAINTENANCE**

5-1	Introduction	5-1
5-3	Factory Repair	5-1
5-5	Test Points	5-1
5-7	Output Regulation Adjustment	5-1
5-9	Current Limit Adjustment	5-1
5-12	Periodic Maintenance	5-2
5-14	Troubleshooting	5-2

TABLE OF CONTENTS (Continued)

SECTION VI
PARTS LIST

6-1	Introduction	6-1
6-3	Spare Parts	6-1

SECTION VII
DIAGRAMS

7-1	Introduction	7-1/7-2
7-3	Diagrams	7-1/7-2

LIST OF TABLES

1-1	Model 251 Performance Specifications	1-3
1-2	Model 501A Performance Specifications	1-3
3-1	Controls and Indicators	3-1

LIST OF ILLUSTRATIONS

1-1	Power Output Derating	1-4
1-2	Typical Harmonic Distortion at Rated Power	1-4
2-1	Models 251 and 501A Rear Panel Connections	2-3
3-1	Controls and Indicators and Front Panel Connections	3-2
4-1	Models 251 and 501A, Block Diagram	4-2
4-2	Interconnections for Multiphase Operation (page 1 of 2)	4-3
4-3	Open-Delta Hook Up	4-5
4-4	Quasi-Square Wave	4-6
5-1	Models 251 and 501A Top View	5-2/5-3
5-2	Models 251 and 501A Bottom View	5-4
5-3	Model 251 Volts Select Board	5-5
7-1	Model 251 Overall Schematic, Dwg. No. 520-101-6X	7-3/7-4
7-2	Model 501A Overall Schematic, Dwg. No. 505-002-6X	7-5/7-6
7-3	Models 251 and 501A Amplifier Board Assembly, Parts Layout Dwg. No. 620-210-00	7-7/7-8

SECTION I GENERAL DESCRIPTION

1-1. INTRODUCTION

1-2. This manual has been prepared for use with the Elgar Models 251 and 501A AC Power Sources. The information it contains is intended for use by operators and trained technicians. The manual provides information regarding the installation, theory of operation and maintenance of the AC Power Source. Also included is a parts list and schematic diagrams to aid in maintaining the unit at optimum performance.

1-3. GENERAL DESCRIPTION

1-4. The Elgar Models 251 and 501A Power Sources provide AC power at precise frequencies for testing, motor operation, and frequency conversion.

1-5. The basic power amplifier consists of two DC power supplies and a direct-coupled amplifier driving a tapped output transformer. The output transformer of the Model 251 provides nominal output voltages of 28, 115, and 230 VAC, that are adjustable between 0-32, 0-130, and 0-260 VAC. The output transformer of the Model 501A provides nominal output voltages of 0-65, 0-130, and 0-260 VAC. The total available power for the Model 251 is 250VA and 500VA for the Model 501A at the rated output voltages.

1-6. Power at less than full-rated output voltage is derated as shown in Figure 1-1. Figure 1-2 shows a typical harmonic distortion curve over the frequency range of both units. The input power for both units is 115 or 230 VAC $\pm 10\%$, 47-53Hz, 1 ϕ .

1-7. Output power frequency is established by a plug-in oscillator module. Output frequency range of the Model 251 at full power is 45 Hz to 5KHz and at rated half power is 5KHz to 10KHz. The output frequency range of the Model 501A is 45 Hz to 5KHz at full power. A variety of fixed and variable frequency plug-in oscillator modules are available with frequency tolerances up to .0001%. (Refer to the specific oscillator manual.)

1-8. The basic power source output is single phase. Multi phase power can be obtained, however, by stacking two or three power sources, all driven by a multi-phase plug-in oscillator module.

1-9. PHYSICAL DESCRIPTION

1-10. The Elgar Models 251 and 501A are each contained in an all-steel enclosure designed with a standard 19-inch rack-mounting and slide-out capability. Refer to paragraph 2-4, Section II for mounting instructions. The front panels of the Models 251 and 501A each contain a voltmeter, a voltage amplitude control, a power circuit breaker and indicator lights.

1-11. The wind tunnel contains the output power heatsink assemblies, which comprise a two-section power amplifier. The voltage amplifier and control circuitry is contained on a plug-in circuit board with test points and adjustment controls available at the top of the board. The Model 251 has a special plug-in board which selects anyone of four output voltage configurations 0-32, 0-130, 0-260 or auxiliary. The auxiliary position supplies the necessary connections for using two amplifiers to gen-

erate three-phase-wye output power, or tandem output connections using two amplifiers in series for two times the output power single phase. Output power of both units is available at the output power terminal block located on the rear of the chassis, and at the red and white binding posts on the front panel.

1-12. The Elgar Plug-In Oscillator module (supplied separately) mounts in the blank space located on the front panel of both power sources. In most cases, however, the power source will already be equipped with this module; depending on the original purchase order. If removal of the oscillator assembly is necessary, the two thumb screws will facilitate its removal or installation.

1-13. The grill assemblies located on the front panel and rear panel provide the fan with the necessary air intake and outlet locations for proper operation. The air is drawn into the front grill and exhausted through the rear grill.

CAUTION

Under no circumstances should the front or rear grill assemblies be blocked or serious damage to the power source may occur.

1-14. PERFORMANCE SPECIFICATIONS

1-15. The performance specifications for the Model 251 and 501A appear in Tables 1-1 and 1-2, respectively. A graph illustrating output power derating appears in Figure 1-1, while still another graph illustrating the typical harmonic distortion of both power sources at rated power appears in Figure 1-2.

1-16. SYSTEM APPLICATIONS

1-17. The Models 251 and 501A can be connected in two's or three's with a common oscillator to provide double power, single-phase, two-phase and three-phase power. The various standard system model numbers available are as follows:

1-18. Model 251 Systems

1. System 500-1

This system consists of (2) Model 251's, (1) Model 400BT Signal-Routing Plug-In and (1) interconnecting cable. Not included with the system but necessary to complete it, is (1) 400(T) plug-in oscillator. This system provides 500VA single-phase, output power, at 65VAC, 130VAC, or 260VAC output voltage.

2. System 500-2

This system consists of (2) Model 251's (1) 400B Signal-Routing Plug-In, and (1) interconnecting cable. Not included with the system, but necessary to complete it, is (1) Elgar 2-phase plug-in oscillator. This system provides 250VA output power per phase at 32VAC, 130VAC or 260 VAC output voltage.

3. System 500-3D

This system consists of (2) Model 251's, (1) Model 400B Signal-Routing Plug-In, and (1) interconnecting cable. Not included with the system but necessary to complete it, is (1) Elgar 3-phase plug-in oscillator. This system is connected in a 3-phase, open-delta configuration. The output power per phase is 166 VA at 32 VAC, 130VAC or 260VAC output voltage.

4. System 500-3Y

This system consists of (2) Model 251's, (1) Model 400B Signal-Routing Plug-In, and (1) interconnecting cable. Not provided with the system, but necessary to complete it is (1) Elgar 3-phase plug-in oscillator. This system is connected in a 3-phase, phantom-wye configuration. The output power per phase is 166VA at 32VAC, 130VAC or 260VAC output voltage.

5. System 750-3

This system consists of (3) Model 251's, (1) Model 400B, (1) Model 400C, and (1) interconnecting cable. Not provided with the system, but necessary to complete it is (1) Elgar 3-phase plug-in oscillator. This system is connected in a three ampli-

Table 1-1. Model 251 Performance Specifications.

OUTPUT		
Power: (VA)	250	
Power Factor @ Full VA	±0.7	
Voltage Ranges (VRMS)	0-32, 0-130, 0-260	
Frequency Range (Hz)	45-10000	
Distortion % @ FL —	45-200 Hz	0.6
	200-1000 Hz	0.4
	1000-5000 Hz	0.6
	5000-10000 Hz	0.9
INPUT		
Voltage (VAC)	115 or 230	
Phase	Single	
Frequency (Hz)	47-63	
Power (approx. max. W.)	800	
PHYSICAL		
Height (in & mm)	5.25	133
Width (in & mm)	19	482
Depth (in & mm)	16	406
Weight, net (lbs. kg.)	70	32
	shipping (lbs. kg.)	80

Table 1-2. Model 501A Performance Specifications

OUTPUT		
Power: (VA)	500	
Power Factor @ Full VA	±0.7	
Voltage Ranges (VRMS)	0-65, 0-130, 0-260	
Frequency Range (Hz)	45-5000	
Distortion % @ FL —	45-200 Hz	0.6
	200-1000 Hz	0.4
	1000-5000 Hz	0.6
	5000-10000 Hz	0.9
INPUT		
Voltage (VAC)	115 or 230	
Phase	Single	
Frequency (Hz)	47-63	
Power (approx. max. W.)	1700	
PHYSICAL		
Height (in & mm)	7	178
Width (in & mm)	19	482
Depth (in & mm)	17	432
Weight, net (lbs. kg.)	100	46
	shipping (lbs. kg)	115

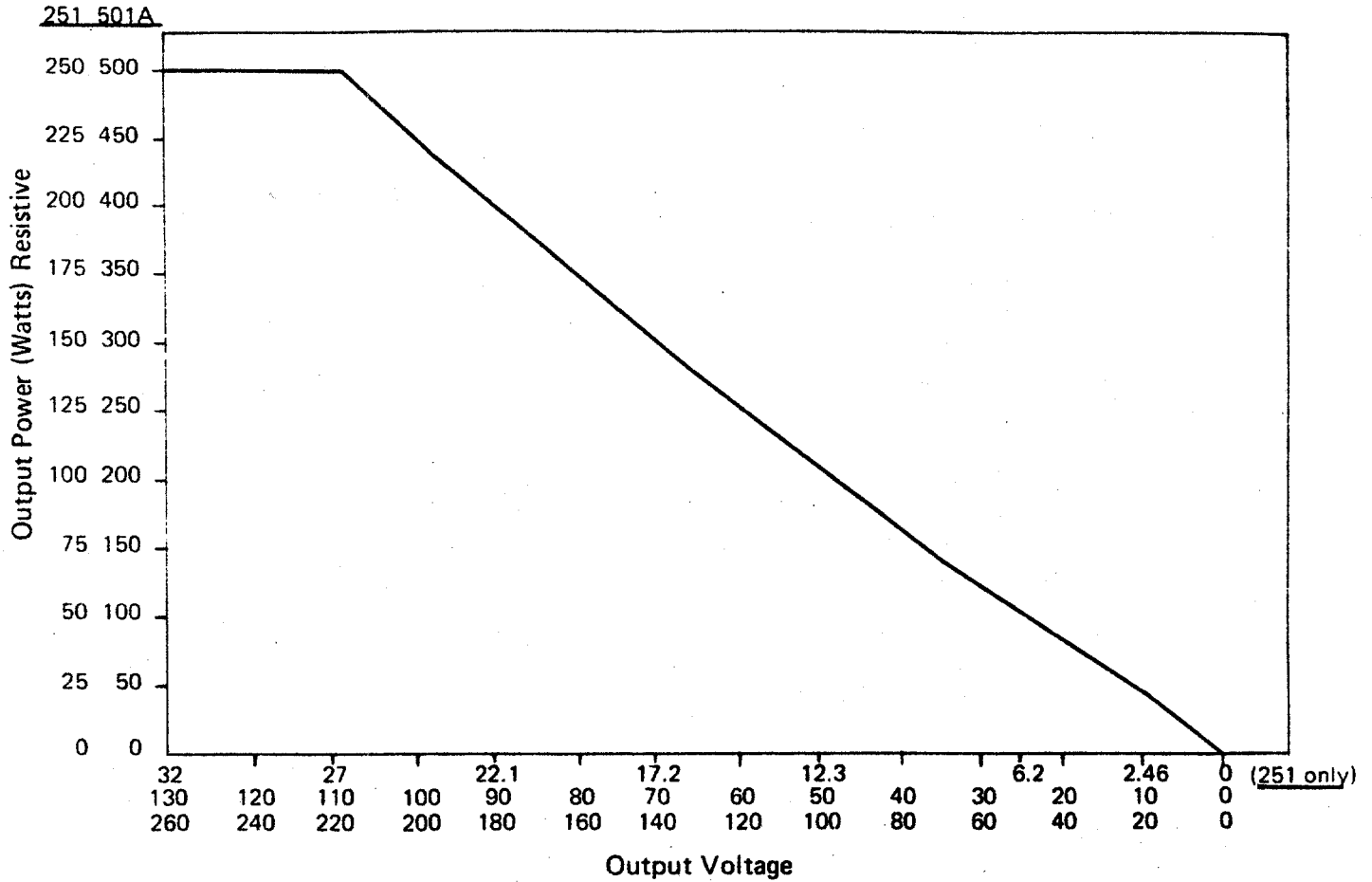

Figure 1-1. Power Output Derating

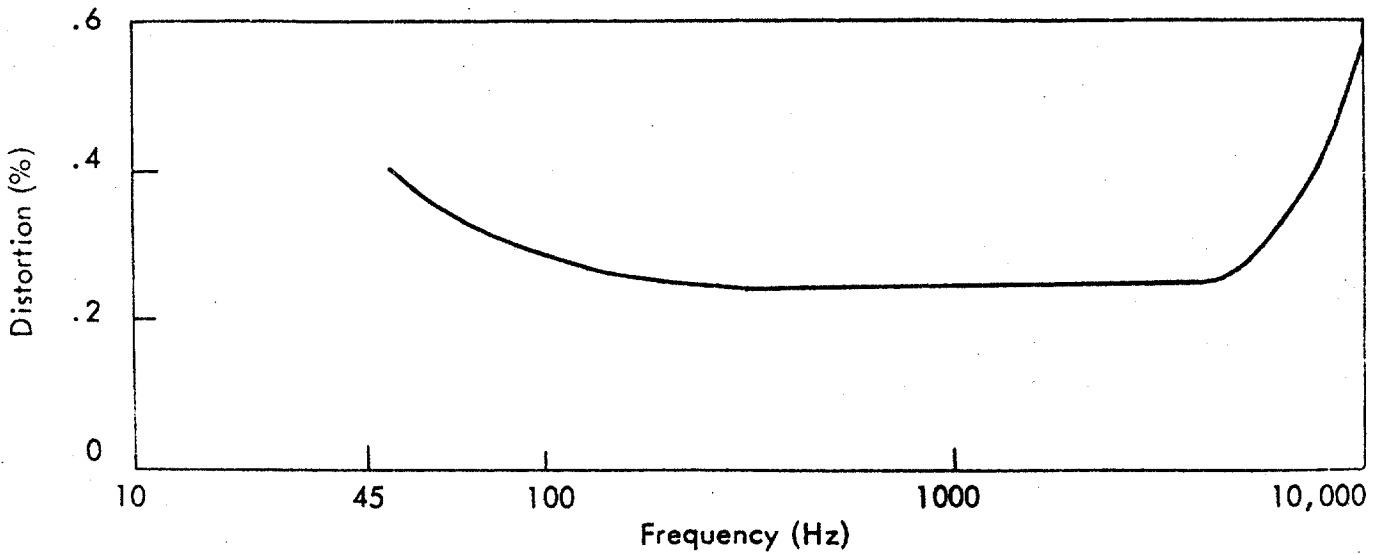

Figure 1-2. Typical Harmonic Distortion at Rated Power

fier, 3-phase, wye configuration. The output power is 250VA per phase at 32VAC, 130VAC or 260VAC output voltage.

figuration. The output power per phase is 333 VA at 65VAC, 130VAC or 260 VAC output voltages.

1-19. Model 501A Systems

1. System 1000-1

This system consists of (2) Model 501A's (1) Model 400BT Signal-Routing Plug-In, and (1) interconnecting cable. Not included with the system, but necessary to complete it, is (1) 400(T) plug-in oscillator. This system requires the two power sources be connected in tandem thus providing 1000VA (1KVA) single-phase output power at 130VAC or 260VAC output voltage.

2. System 1000-2

This system consists of (2) Model 501A's (1) Model 400V, and (1) interconnecting cable. Not included with the system, but necessary to complete it, is (1) Elgar 2-phase plug-in oscillator. This system provides 500VA power output per phase at 65VAC, 130VAC or 260VAC output voltage.

3. System 1000-3D

This system consists of (2) Model 501A's, (1) Model 400V, and (1) interconnecting cable. Not included with the system, but necessary to complete it, is (1) Elgar 3-phase plug-in oscillator. This system is connected in a 3-phase open-delta con-

4. System 1000-3Y

This system consists of (2) Model 501A's, (1) Model 400V Signal-Routing Plug-In, and (1) interconnecting cable. Not included, but necessary to complete the system, is (1) Elgar 3-phase plug-in oscillator. The system is connected in a 3-phase, phantom-wye configuration and has 333 VA power output per phase at 65VAC, 130VAC or 260VAC output voltage.

5. System 1500-3

This system consists of (3) Model 501A's, (1) Model 400V, (1) Model 400C, and (1) interconnecting cable. Not included with the system, but necessary to complete it is (1) Elgar 3-phase plug-in oscillator. The system is connected in a three-amplifier 3-phase wye configuration. The output power per phase is 500 VA at output voltages of 65VAC, 130VAC or 260VAC output voltage.

1-20. Whenever a standard Elgar System has been ordered with a cabinet, the system model number will be preceded with the letter C. Information concerning the output connections of any of the standard systems appears in Section II of this instruction manual. Information concerning calibration of Systems 500-1 and 1000-1 appears in Section V.

SECTION II INSTALLATION

2-1. INTRODUCTION

2-2. The Models 251 and 501A AC Power Source units have been calibrated and quality tested prior to shipment. The units, therefore, are ready for installation and operation upon receipt. Instructions in this section must be followed to ensure proper inspection upon receipt of the unit and correct installation.

2-3. UNPACKING AND RECEIVING INSPECTION

2-4. The unit has been packed in accordance with industrial standards for safe shipment. Upon receipt of the unit, unpack and inspect the unit as described in the following steps:

1. Visually inspect the unit exterior for any signs of damage, such as dents, scratches, or distortion.
2. Check the front panel controls for ease of operation.
3. Ensure that the front panel indicators are not damaged.
4. Inspect the front panel mounted meters and ensure they are not damaged.
5. Remove the top cover and ensure all circuit boards are securely seated in their respective connectors. Re-install top cover.

6. If the power source has been equipped with a plug-in module, remove and inspect it for any signs of damage. Re-install the plug-in module. Removal and reinstallation of the plug-in module is facilitated by the use of two thumb-screws located on the front of the plug-in module.

NOTE

If any physical damage is evident, file a claim for concealed damage with the carrier agent and save all shipping materials for inspection. Forward a report of damage to the ELGAR Repair Department. Elgar will provide instructions for repair or replacement of the instrument.

ELGAR
Repair Department
9250 Brown Deer Road
San Diego, CA 92121-2294
1-800-733-5427
Tel: (858) 450-0085
Fax: (858) 678-4482
www.elgar.com

2-5. RACK MOUNTING

2-6. Both power sources have been designed to allow rack mounting in a standard 19-inch instrument rack. The physical dimensions of both units are given in Tables 1-1 and 1-2 in Section I.

2-7. For slide-out capability, the power sources have been built with threaded screw holes on both

sides of the units to allow for installation of the Zero Mfg. Co. chassis slides, part number CTN-120.

CAUTION

When mounting the Model 251 or 501A, ensure that the flow of air into the fan intake or outlet is not obstructed or serious damage may occur to the unit.

2-8. INSTALLATION

2-9. Power Requirements

2-10. Both AC Power Sources operate from either 115VAC or 230VAC, single phase, 47 Hz to 63 Hz input power. The maximum input power (approximately) of the Model 251 and 501A is 800 watts and 1700 watts, respectively.

2-11. For 115VAC input voltage operation of the Model 251 or 501A, connect jumpers to input transformer T1 as follows: pin 1 to pin 3 and pin 2 to pin 4. For 230VAC operation, connect a jumper from pin 2 to pin 3 and remove the jumpers for the 115VAC operation. (Refer to Figures 7-1 and 7-2, Overall Schematics in Section VII.)

2-12. Plug-In Modules

2-13. In most cases, the Model 251 or 501A will already have a plug-in oscillator, signal-routing plug-in or a blank panel installed. However, in the event installation of one of these plug-in modules is necessary, the two thumb screws will facilitate their installation or removal.

2-14. External Oscillators, Programming and Synchronization

2-15. In some applications it may be desirable to use an external oscillator rather than an Elgar plug-in module. If this situation exists, the blank space in the front panel should contain a blank filler panel (supplied separately).

2-16. When using an external oscillator, all input and control signals should be connected to J1, a 12-pin Cinch-Jones connector. J1 is located on the rear panels of the Models 251 and 501A. (Refer to Figure 2-1.) Connector J1 may also be used for external amplitude programming and synchronization of the internal Elgar plug-in oscillator to an external timing source. It is important to know that when an external oscillator is used, the input impedance must be matched to the input operational amplifier to obtain a gain of 1.

2-17. CHECKOUT

2-18. The Models 251 and 501A may be checked out as follows:

1. Inspect the plug-in oscillator.
2. Connect the load to the appropriate terminal of the rear panel power output terminal block (See Figure 2-1). For bench-mounted applications, the front panel binding posts may be used for 28V, 115V, or 230V output on the Model 251 and 115V or 230V output on the Model 501A.
3. Connect the input power cord on the rear panel to an appropriate source of single-phase power.
4. Set the front panel power switch to the ON position. The indicator lamp that lights indicates the output voltage range as selected by the plug-in volts select board. If the other range is desired, remove top cover of the unit and plug opposite end of volts select board into the connector (Model 251 only). Re-install top cover.
5. Adjust front panel AMPLITUDE control for the desired output voltage as indicated on the front panel voltmeter.

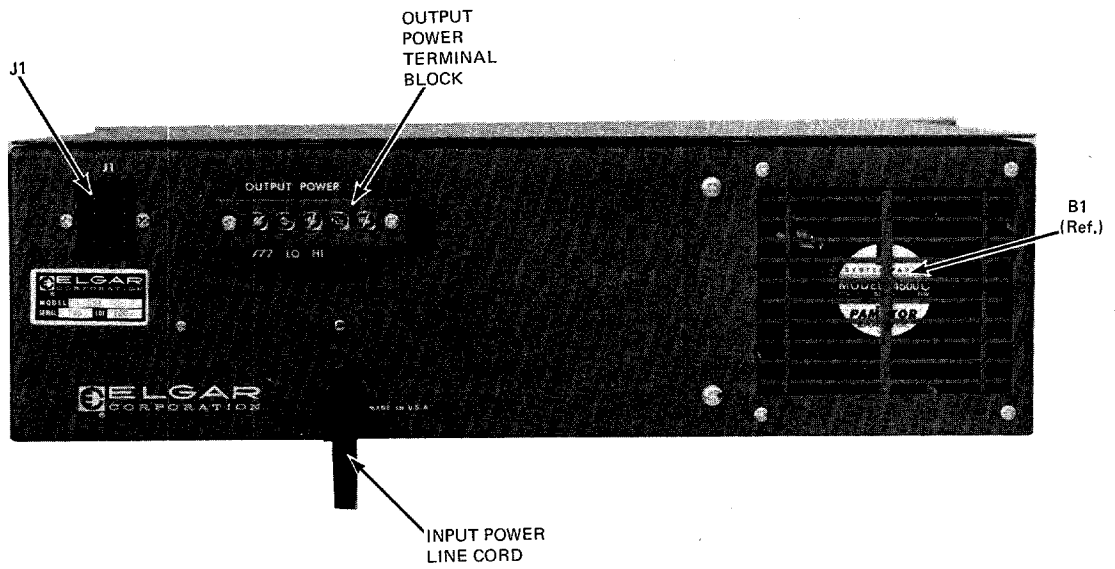

MODEL 251

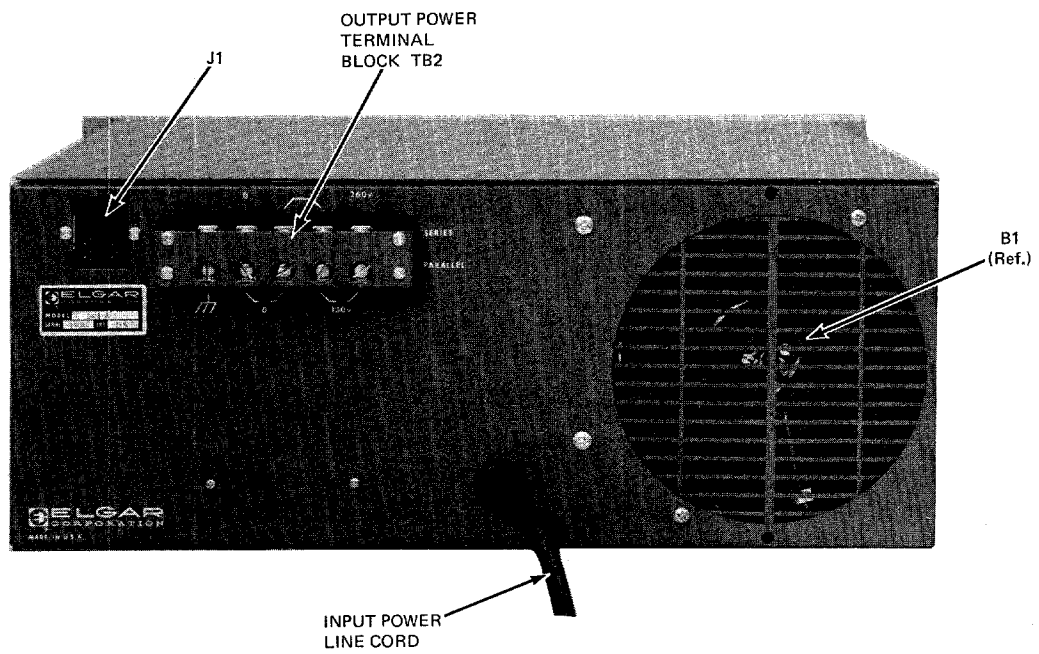

MODEL 501A

Figure 2-1. Model 251 and 501A Rear Panel Connections

**SECTION III
OPERATION**

3-1. INTRODUCTION

3-2. This section describes the controls and indicators of the Models 251 and 501A, respectively. The controls and indicators are called out in Figure 3-1. The functions of the controls and indicators are given in Table 3-1. (Refer to Oscillator

Instruction Manual for a description of the controls on the oscillator plug-in module.)

3-3. CONTROLS AND INDICATORS

3-4. The controls and indicators of Models 251 and 501A are described in Table 3-1.

TABLE 3-1. CONTROLS AND INDICATORS

Control and Indicator	Function
Input Power Circuit Breaker CB1	Applies AC input power to unit.
Indicator Lamp DS1 (Model 501A)	Lights to indicate power has been applied to unit.
Indicator Lamp DS1 (Model 251)	Lights when output voltage is selected at 0-32 volts.
Indicator Lamp DS2 (Model 251)	Lights when output voltage is selected at 0-130 volts.
Indicator Lamp DS3 (Model 251)	Lights when output voltage is selected at 0-260 volts.
AC Voltmeter M1	Monitors output voltage in AC ranges: 0-35 (Model 251) 0-150 (Model 251 and 501A) 0-300 (Model 251)
AMPLITUDE Control Potentiometer R1	Adjust input signal amplitude of oscillator.

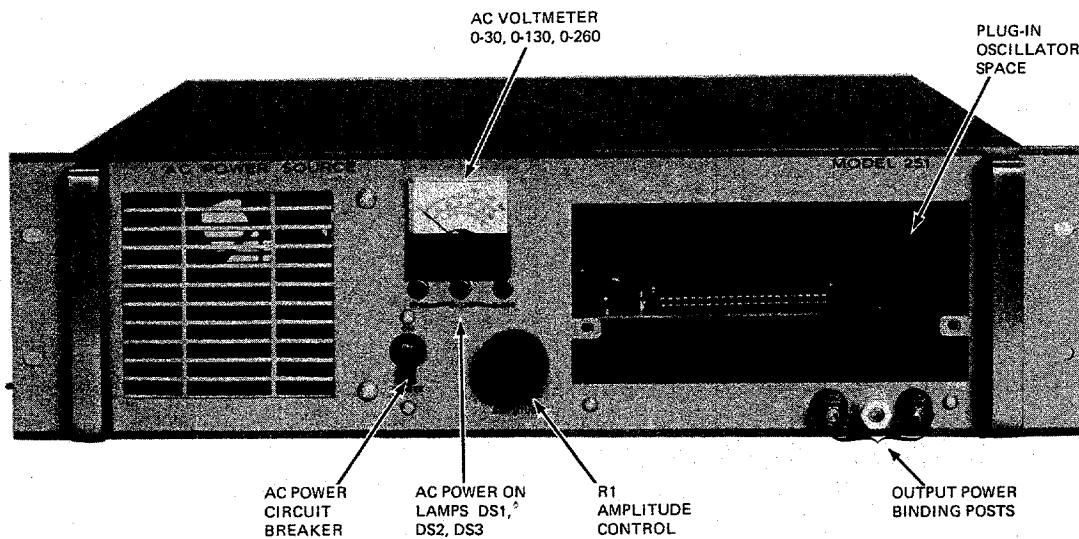

MODEL 251

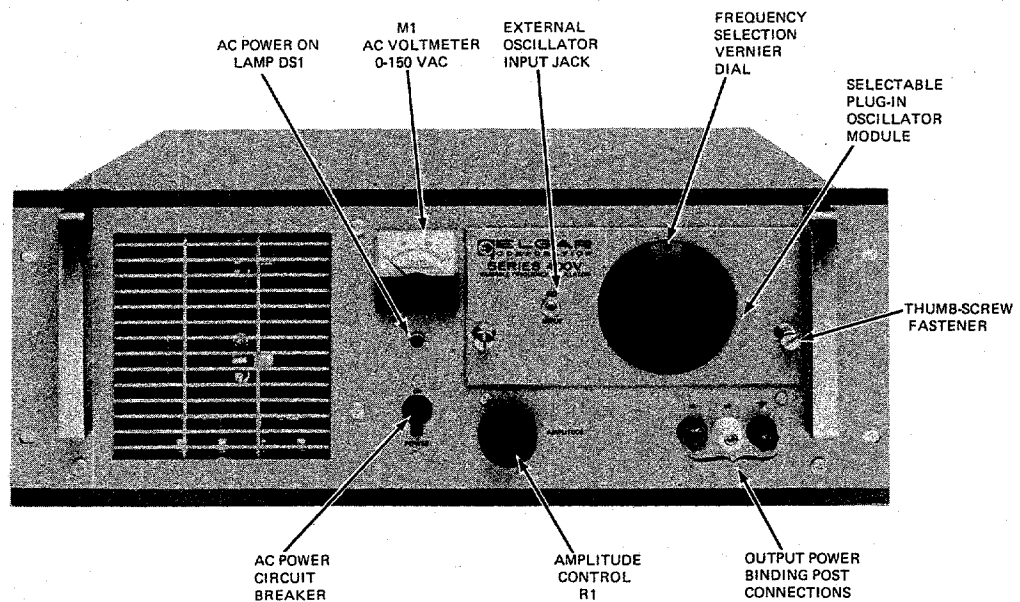

MODEL 501A

Figure 3-1. Controls and Indicators and Front Panel Connections

SECTION IV

THEORY OF OPERATION

4-1. CIRCUIT DESCRIPTION (Refer to Figures 4-1, 7-1, and 7-2.)

4-2. The input signal, approximately 3 VRMS, is provided by the plug-in oscillator. For most oscillators, the input signal amplitude is controlled by front panel AMPLITUDE control, R1. The signal is applied to the first amplifier stage consisting of differential amplifier Q1 and Q2. The differential amplifier provides high DC stability. The emitter currents are supplied by R6 from a +12V supply regulated by CR5. The output of Q1 is coupled to the base of Q5 which provides drive signals to the complementary driver stage, Q6 and Q7. Q6 operates as an emitter-follower to drive emitter-follower Q8, which provides base drive signals to the upper half of the push-pull class B power amplifier. Q7 is operated as a common emitter stage to provide phase inversion of the drive signals to the lower half of the power amplifier. The output of Q7 is applied to emitter-follower Q16 which provides base drive signals to the lower half of the power amplifier.

4-3. The power amplifier consists of a number of power transistors mounted on two heatsinks. The .22 ohm emitter resistors ensure equal current sharing of the output transistors. The driver and output stages are operated from nominal ± 42 VDC supplies. Thermal switch S1 shown on heatsink No. 1 turns drive signals off to the power amplifier in the event the power amplifier overheats from excessive load or restricted airflow through the wind tunnel.

4-4. The power amplifier is also protected from overloads or short circuits on the output by current

limit transistors Q3 and Q4. The current in the upper half of the power amplifier is sampled by R32 and applied across upper limit adjustment potentiometer R24. The current signal is then applied to the base of Q3 through R21. When the voltage at the base of Q3 reaches Q3's conduction threshold (approximately 0.6V) the drive signal is diverted from the base of Q6, preventing any further increase in output current. Simultaneously, the current in the lower half of the power amplifier is sampled across R32 and applied across lower limit adjustment potentiometer R25. This signal is then applied to the base of Q4 through R22. When the voltage at the base of Q4 reaches Q4's conduction threshold, the drive signal is diverted from the base of Q7 preventing a further increase in output current.

4-5. Amplifier output (TP2) is connected to output transformer T2, which steps up the amplifier voltage to the required output level. Negative AC feedback path is from TP2 through R13 to the base of Q2. Capacitor C6 across R13 is used to prevent high-frequency oscillations in output. Load regulation is accomplished by passing the TP2 wire from the heatsink plugs through a current transformer T3. Positive current feedback is taken across the secondary through regulation adjustment potentiometer R14 and to the base of Q2 through R11. R12 and C4 are used as a high-frequency regulation boost network.

4-6. POWER SUPPLIES

4-7. Plus and minus 42VDC for the amplifier is developed by the full-wave bridge rectifier on the secondary of T1. Filter capacitors and supply

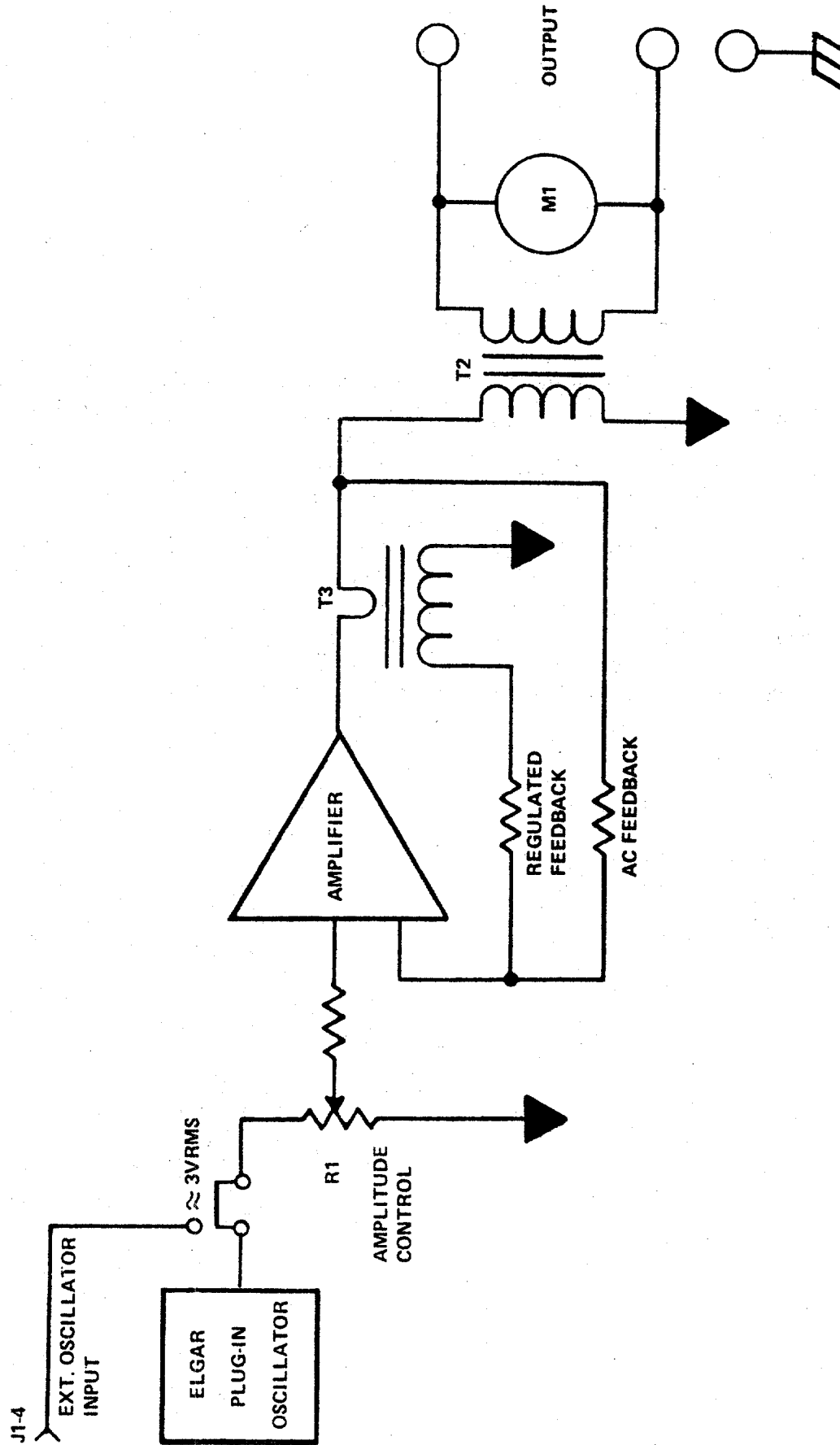
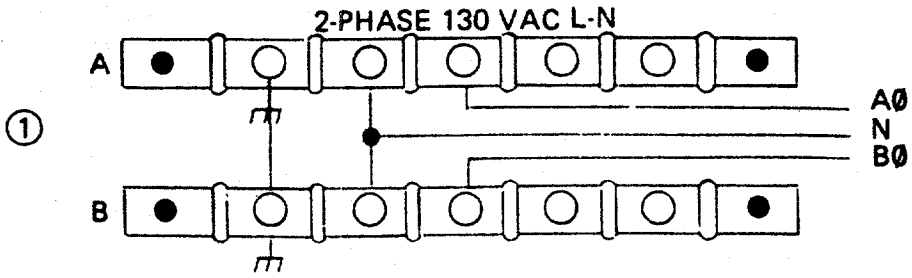

Figure 4-1. Models 251 and 501A, Block Diagram

CONFIGURATION

OUTPUT CONFIGURATIONS FOR MODEL 251



NOTE: 28V OR 230V OUTPUTS ARE ALSO AVAILABLE FOR ALL CONFIGURATIONS EXCEPT 3 AND 5, BY ROTATING VOLTS SELECT CARD TO DESIRED OUTPUT VOLTAGE POSITION

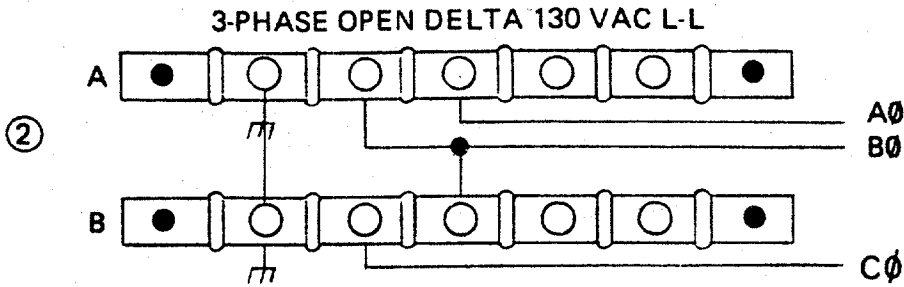

20-100-20
1, 2, 3, 4

20-102-20
1, 2, 3, 4, 5

NO 260V OUTPUT WITH 20-102-20 VOLTS SELECT CARD

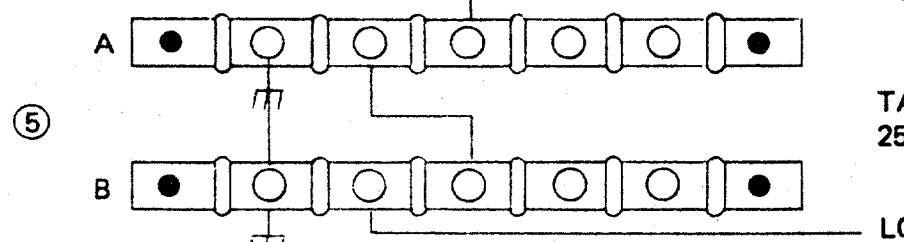
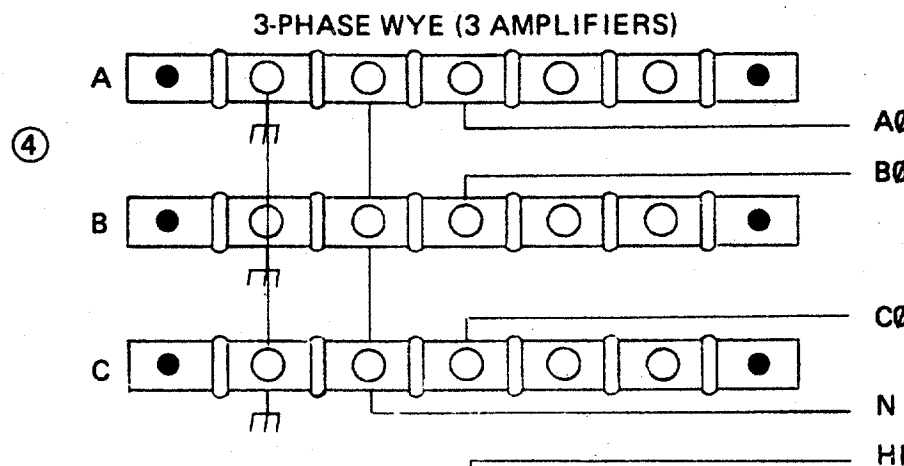
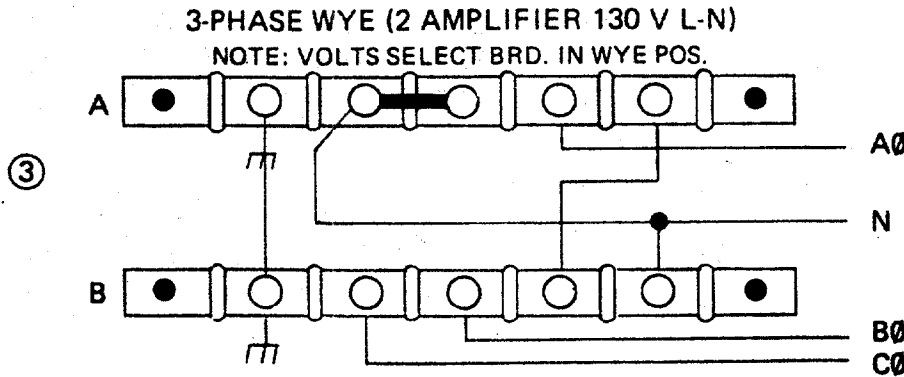

SPECIAL VOLTS SELECT CARD REQUIRED

20-102-20

TANDEM
251 ONLY

Figure 4-2. Interconnections for Multiphase Operation (Page 1 of 2)

OUTPUT CONFIGURATIONS FOR MODEL 501A

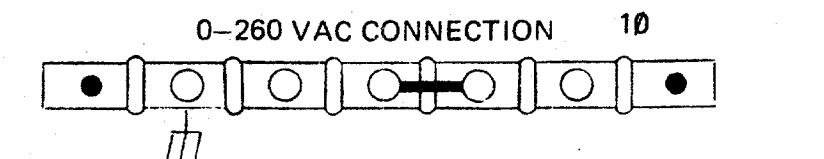
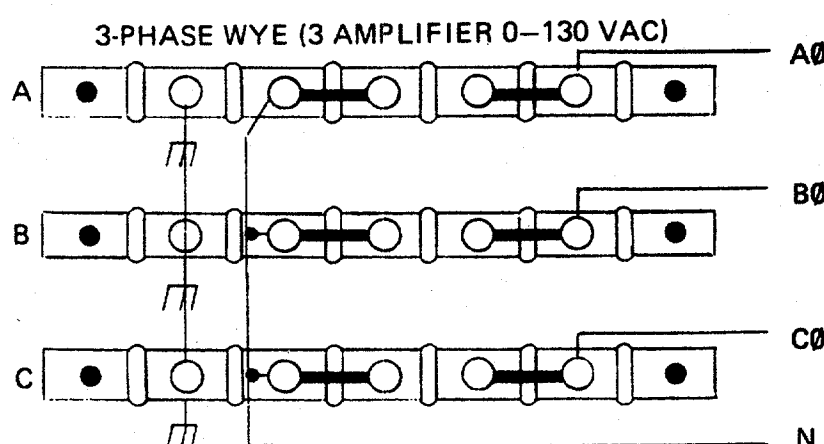
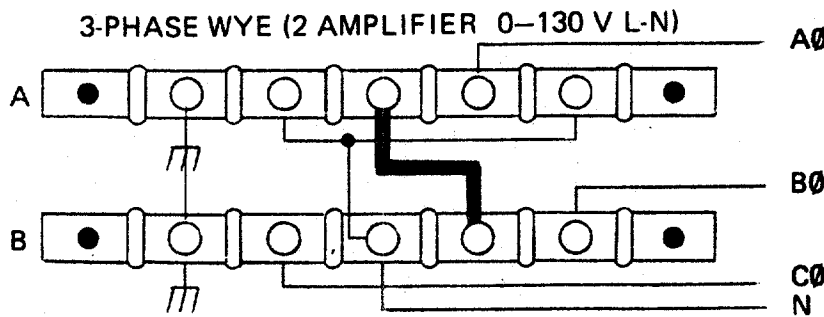
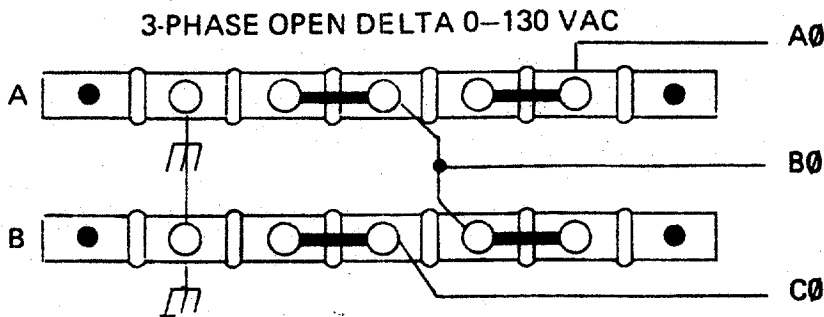
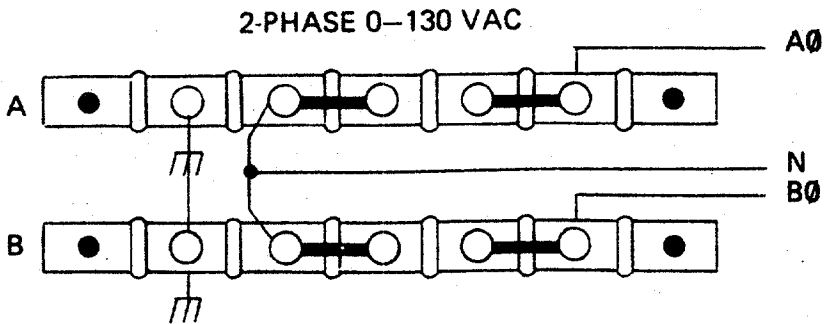

EACH AMPLIFIER PLUS INTERCONNECTION BETWEEN UNITS. VALID FOR ALL BUT 2 AMP WYE

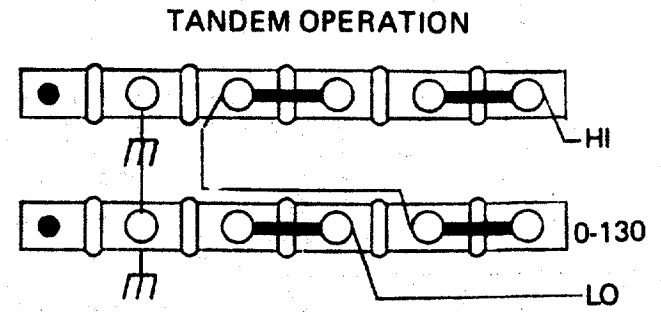

NOTE: FOR TANDEM OPERATION INTERNAL JUMPERS FOR OUTPUT TRANSFORMER MUST BE CHANGED REFER TO 501A SCHEMATIC

FOR TANDEM OPERATION, 260V OUTPUT USE STD. INTERNAL CONNECTIONS AND 0-130V OUTPUT.

Figure 4-2. Interconnections for Multiphase Operation (Page 2 of 2)

bleeder resistors are connected across the output of the bridge.

4-8. INTERCONNECTIONS FOR MULTI-PHASE OPERATION

4-9. Two or three Power Sources may be used to generate two-phase or three-phase AC power. Two-phase or three-phase signals are generated in a two-phase or three-phase oscillator installed in the master power amplifier. Signals from the oscillator are carried to one or two slave power amplifiers (see Figure 4-2), each of which has a blank signal routing plug-in which makes the required signal interconnections to the power amplifier. The front panel AMPLITUDE control on the master amplifier controls the amplitude of all the amplifiers outputs simultaneously. Upon initial installation of the system, the A phase power amplifier should be turned on first and the output voltage adjusted to the desired level. Next energize the B phase unit and set its output voltage to equal the A phase unit. When applicable, repeat for C phase power amplifier. Some minor adjustments to the A, B, and C phase units will be necessary to initially calibrate the system.

4-10. Two-phase operation requires two power sources. Three-phase operation may be accomplished with three power sources in wye connection, or with two power sources in open-delta connection. A more detailed description of two-phase and three-phase power generation is provided in the oscillator instruction manual.

4-11. In the open-delta configuration, two power amplifiers of equal VA rating are driven by a standard three-phase oscillator having 120° phase angle between $\emptyset A$, $\emptyset B$ and $\emptyset C$. An open delta requires that the two amplifiers have a 60° phase angle between them and this is accomplished by inverting the second amplifier.

4-12. In these systems, the amplifier containing the plug-in oscillator is referred to as the master or A-phase source. The second amplifier is referred to as the slave or B-phase source.

4-13. The open-delta hook-up shown in Figure 4-2 is shown below as a vector diagram in Figure 4-3.

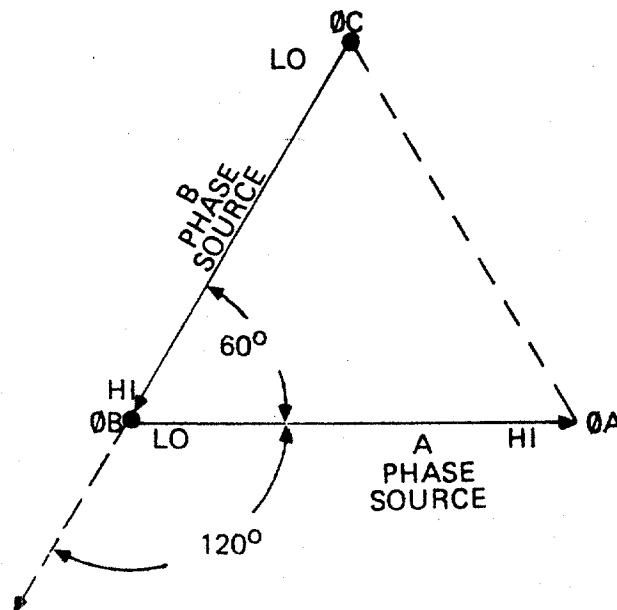

Figure 4-3

4-14. Certain specialized oscillators such as the Super Stable (SS) series and the Quasi-Square wave series are designed only for open-delta configurations using two amplifiers and having the phase

angle between the $\emptyset A$ and $\emptyset B$ drive signals at 60° .

4-15. When using the SS series or quasi-square wave systems the interconnections would be as shown in Figure 4-4.

QUASI-SQUARE WAVE SUCH AS 443-1-111

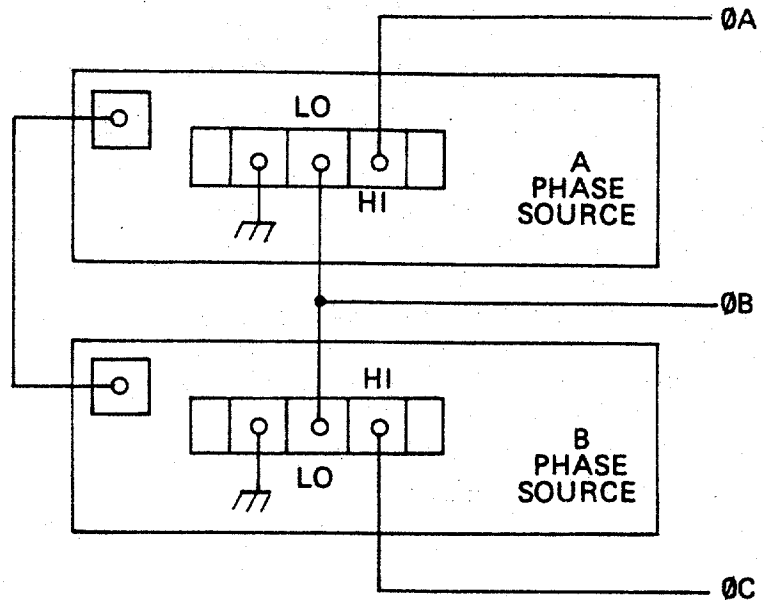
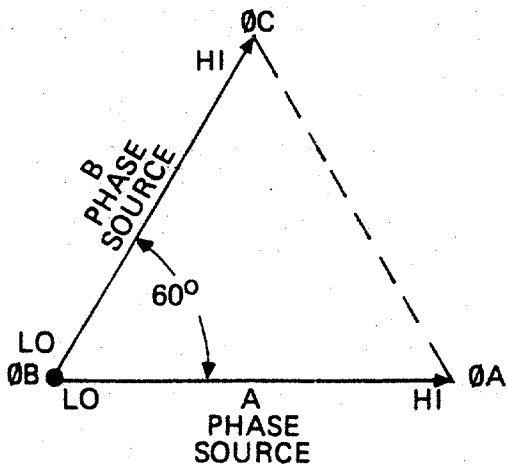

SUPER STABLE SUCH AS 443-01SS

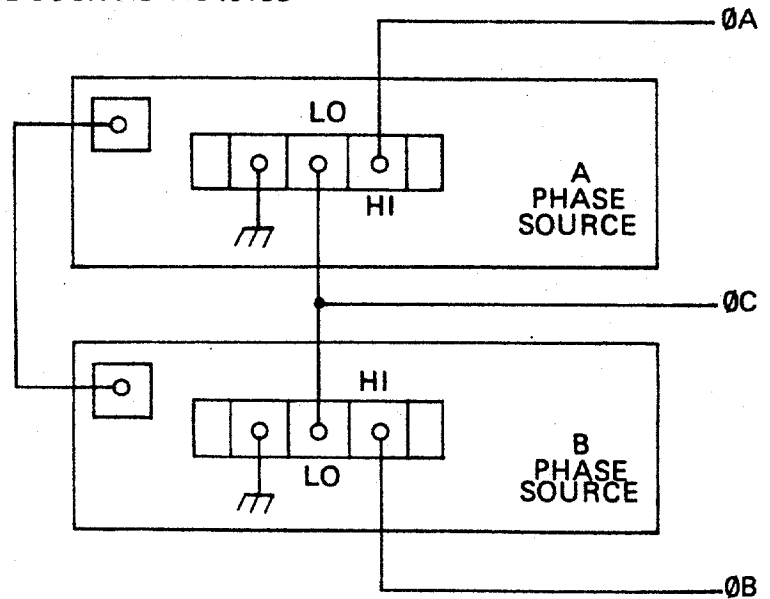
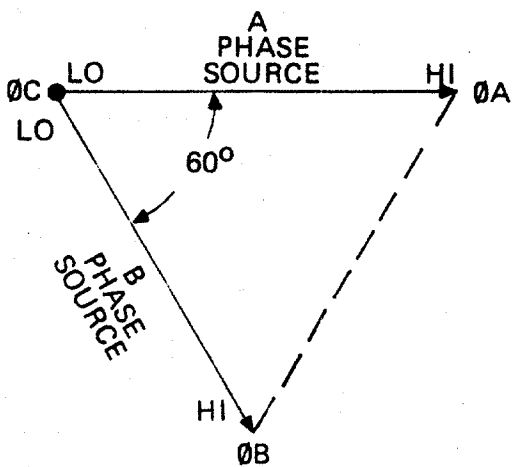

Figure 4-4

SECTION V
MAINTENANCE

5-1. INTRODUCTION

5-2. This section provides maintenance information of a general nature. Specific questions concerning the operation, repair or servicing of the unit should be directed to the ELGAR Repair Department. Include the model and serial number in any correspondence concerning the unit.

5-3. FACTORY REPAIR

5-4. Should it be necessary to return a unit to the factory for repair, please contact ELGAR Repair Department for authorization to make shipment. **DO NOT RETURN THE UNIT WITHOUT AUTHORIZATION.**

ELGAR
Repair Department
9250 Brown Deer Road
San Diego, CA 92121-2294
Tel: (858) 450-0085
Fax: (858) 678-4482
www.elgar.com

5-5. TEST POINTS

5-6. Test points and adjustment controls are conveniently provided at the top of the amplifier circuit board, accessible by removing the top cover of the unit (see Figure 5-1). The test points are as follows;

- TP1 – Circuit common – turret terminal
- TP2 – Amplifier output – red
- TP3 – Oscillator signal – orange

5-7. OUTPUT REGULATION ADJUSTMENT

5-8. The regulation adjustment, R14, is set at the factory to give $\pm 1\%$ load regulation over the full frequency range of the power source. The regulation may require re-adjustment if the load is highly reactive or if zero regulation is desired for a specific load and frequency. To make this adjustment, disconnect the load and read the output voltage. Connect the load and adjust R14 until the same reading is obtained.

NOTE

If the load is heavy enough to cause current limit transistors Q3 and Q4 to conduct, the output voltage will be reduced, giving an indication of poor load regulation. Load voltage fall-off due to current limiting action should not be compensated by the regulation adjustment.

5-9. CURRENT LIMIT ADJUSTMENT

5-10. The current limits have been preset at the factory such that the unit will deliver full rated power at rated output voltage. Re-adjustment of the limits should not be performed unless a malfunction has occurred in the unit, parts have been replaced and re-adjustment of the limits is indicated.

5-11. Current limit adjustment may be checked by observing the waveform at TP2 with an oscilloscope.

1. Set scope sensitivity to 10 v/cm.
2. Turn unit on and adjust output for 110 VAC as indicated on the front panel meter.

3. Connect 46 ohm load to output terminals of 251, 23 ohm on the 501A.
4. Adjust current limit potentiometers CW until clipping is observed at TP2. Adjust limit potentiometers CCW until clipping just disappears.

5-12. PERIODIC MAINTENANCE

5-13. The only periodic maintenance required by the power source is an occasional cleaning of the heatsinks. The heatsinks may be inspected through the front panel air grill. If enough dust and dirt have accumulated to restrict the air flow, an air jet should be directed through the front panel grill while the unit is operating. If this does not dislodge the dirt, the heatsink must be removed to be cleaned.

5-14. TROUBLESHOOTING

5-15. **CIRCUIT BREAKER TRIPS.** If the circuit breaker trips at no load, a fault in either the power transistors or power rectifiers is indicated. Unplug

both heatsinks and try the circuit breaker. If it does not trip, look for a shorted power transistor, (power transistors can be tested with an ohmmeter). If the circuit breaker still trips, look for a shorted rectifier bridge. If all diodes and filter capacitors are good, a fault in the power transformer or wiring harness is indicated.

5-16. **OUTPUT DISTORTION.** Output distortion may be caused by overloading. Check the load current waveform with an oscilloscope since some high crest factor loads may draw considerably more peak current than is indicated by a load ammeter.

5-17. **OVERHEATING.** If overheating causes thermostat S1 to close, the output voltage will fall to zero. Overheating may be caused by restricted air flow or excessive environmental temperature (greater than 50°C).

5-18. **COMPONENT LOCATIONS.** Refer to Figures 5-1 through 5-3 for major component locations in Models 251 and 501A. Also, refer to Section VII for parts layouts of board assemblies.

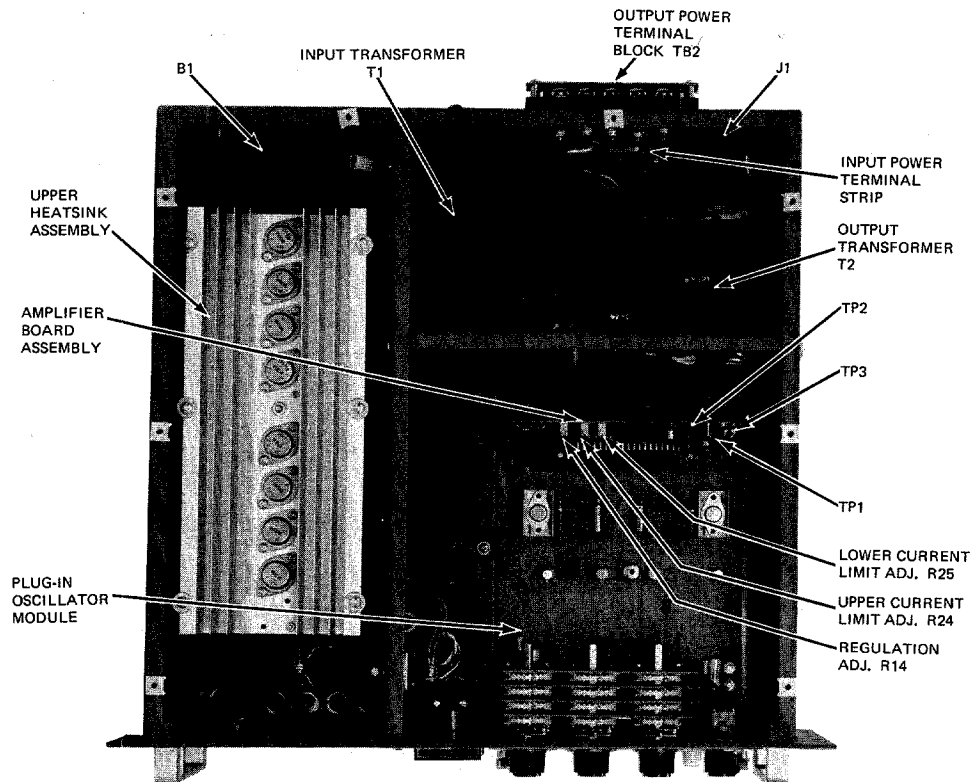

Figure 5-1. Model 501A Top View

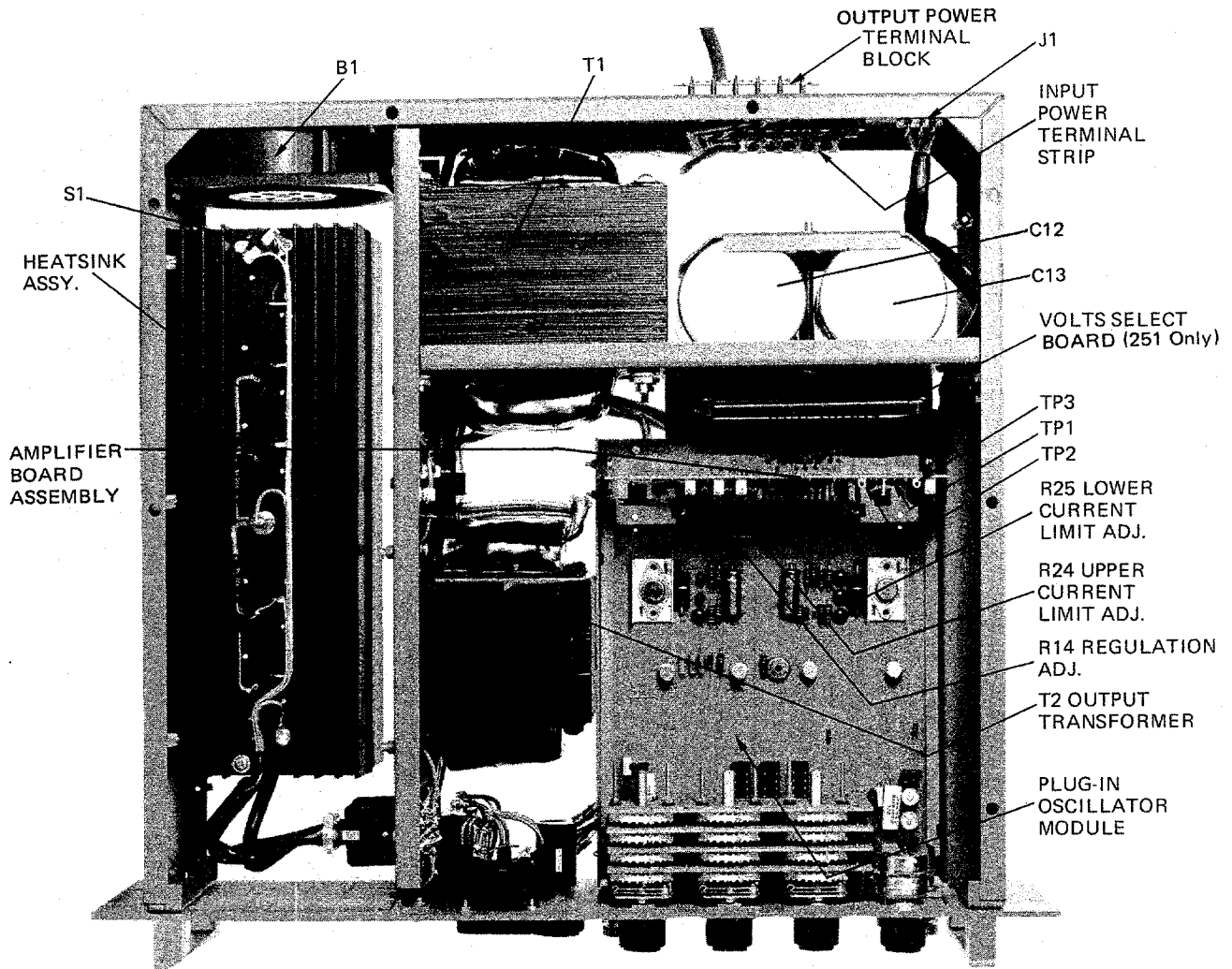
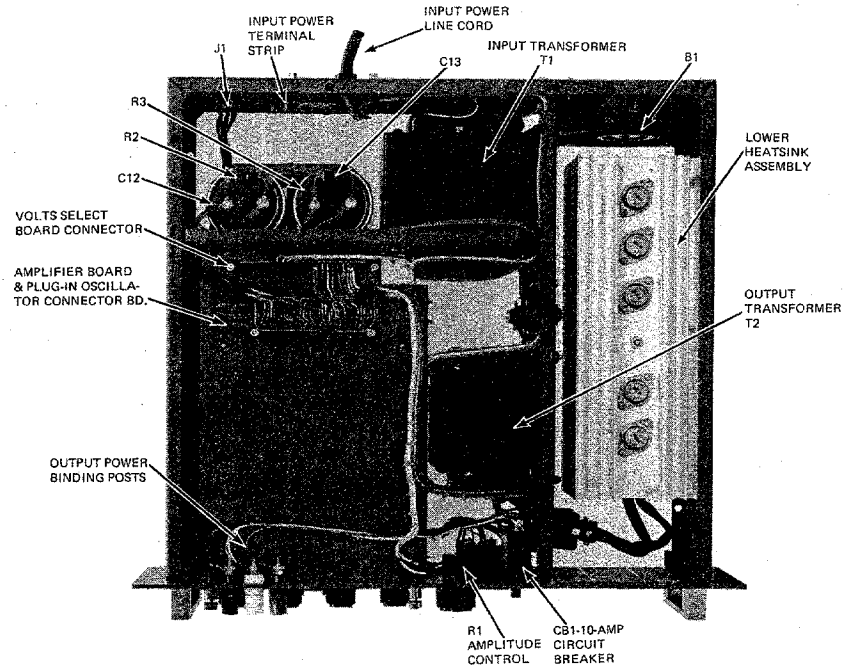
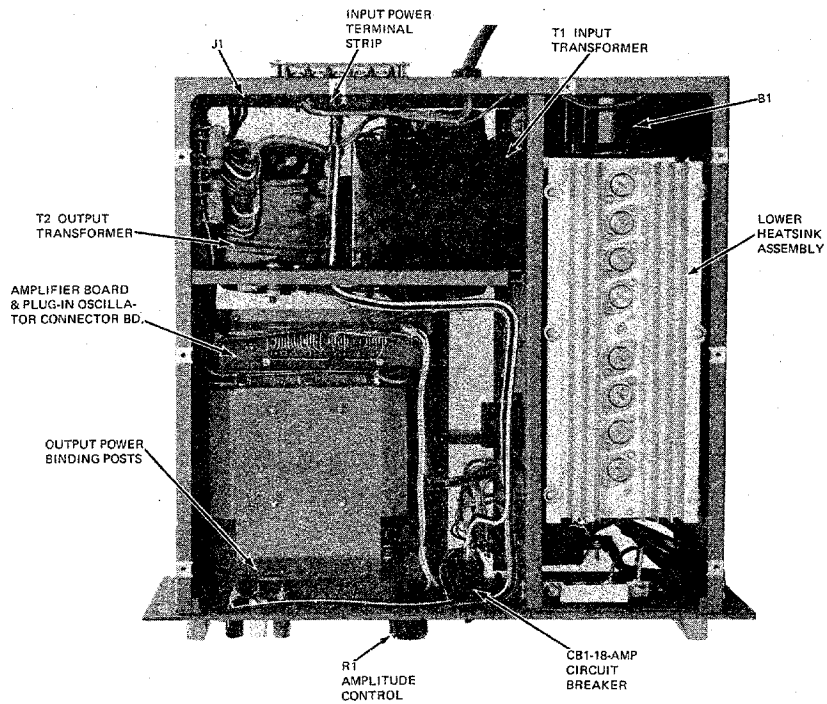

Figure 5-1. Model 251 Top View



MODEL 251



MODEL 501A

Figure 5-2. Bottom View

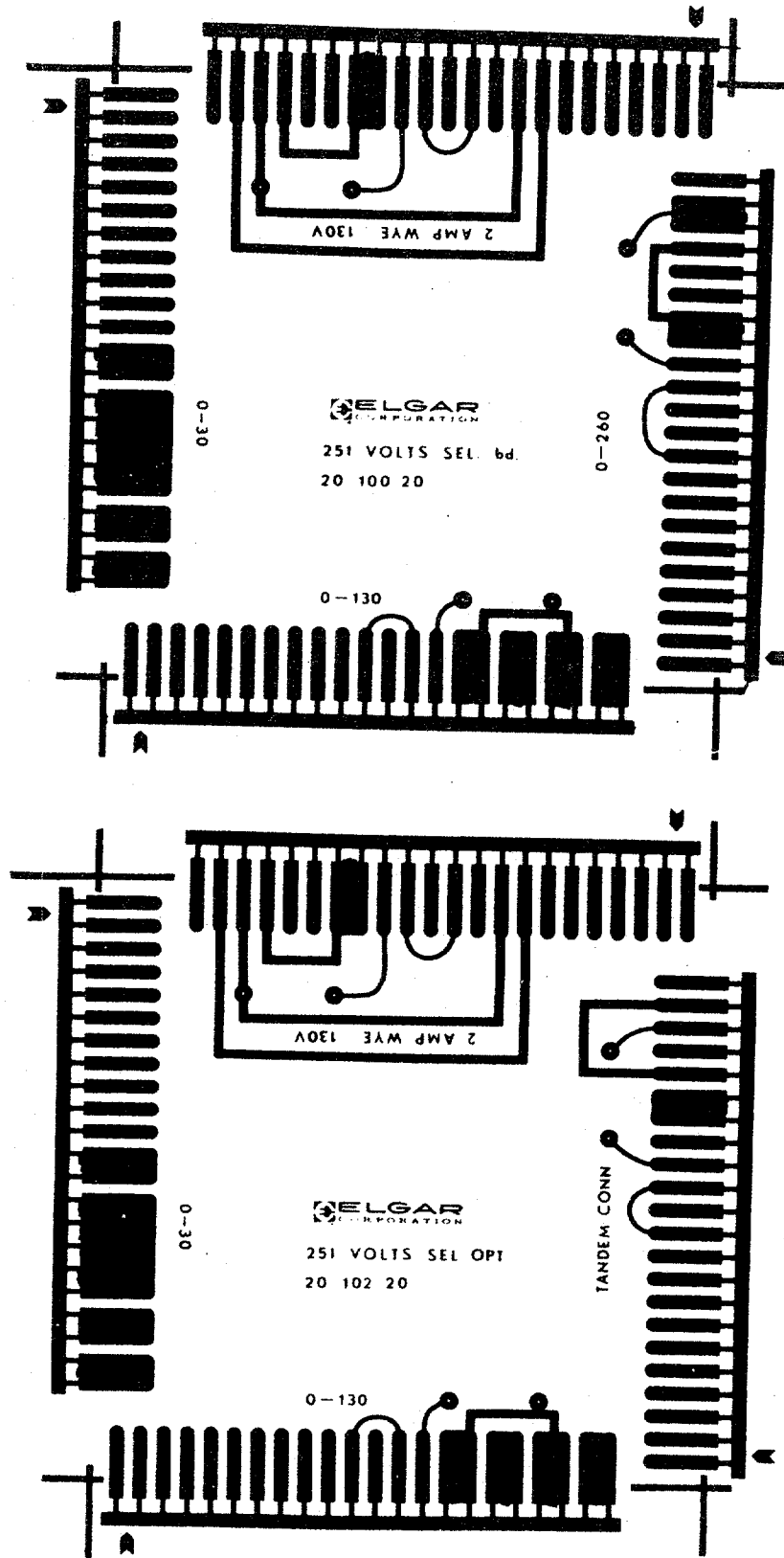

Figure 5-3. Model 251 Volts Select Board



**SECTION VI
PARTS LIST**

6-1. INTRODUCTION

6-2. This section contains a listing of repair parts for Model 251 and Model 501A. The reference designations listed correspond to the schematic designations on the diagrams in Section VII.

6-3. SPARE PARTS

6-4. When ordering spare parts, specify part name, part number, manufacturer, component value and rating, and the Elgar part number. If complete assemblies are desired, contact:

ELGAR ELECTRONICS CORPORATION
Sales & Technical Support
9250 Brown Deer Road
San Diego, CA 92121-2294
1-800-733-5427
Tel: (858) 450-0085
Fax: (858) 458-0267
E-mail: sales@elgar.com
www.elgar.com

Specify assembly number, unit series number and unit model number when ordering.

AMPLIFIER BOARD, ASSEMBLY NO. 620-210-4X

SCHEMATIC DESIGNATION	VALUE	DESCRIPTION OR TYPE	RATING	MANUFACTURER		ELGAR PART NUMBER
				NAME	PART NUMBER	
C1	10 uF	Met. Mylar	200V, 5%	IMB	ZA2C106J	822-106-20
C2,C4	FSV	Paper	200V, 5%	Sprague	192P	822-106-20
C3	120 pF	Dip Mica	500V, 5%	ARCO	DM15121J	820-121-05
C5	220 uF	Tantalum	10V	Sprague	196B227X0010MA3	823-227-61
C6	.0015 uF	Cer. Disc	1 KV, 10%	Centralab	CF152	821-152-00
C7	.0033 uF	Cer. Disc	1 KV, 10%	Erie	Z5U332J	821-332-00
C8	50 uF	Alum. Elect.	50V	Sprague	500D506G050DD7	824-506-71
C9,C10	.02 uF	Cer. Disc	50V, 10%	Centralab	DDM203	821-202-00
C11,C24	220 pF	Dip Mica	500V, 5%	ARCO	DM15-221J	820-221-05
R4,R13	5.11K	Met. Film	1/8W, 1%	Dale	RN60C5111F	813-511-1F
R5	3.9K	Carb. Comp	1/2W, 5%	Speer	RC20GF392J	802-392-05
R6,9,26,27	4.7K	Carb. Comp	1/2W, 5%	Speer	RC20GF472J	802-472-05
R7,12,17	FSV	Carb. Comp	1/2W, 5%	Speer	RC20GF	802-...-05
R8	1.5K	Carb. Comp	1/2W, 5%	Speer	RC20GF152J	802-152-05
R10	475 ohm	Met. Film	1/8W, 1%	Dale	RN60C4750F	813-475-0F
R11	2.61K	Met. Film	1/8W, 1%	Dale	RN60C2611F	813-261-1F
R14	1K	Potentiometer		Bourns	3059-1K	819-102-30
R15,21,22	68 ohm	Carb. Comp	1/2W, 5%	Speer	RC20GF680J	802-680-05
R16,19,29,30	100 ohm	Carb. Comp	1/2W, 5%	Speer	RC20GF101J	802-101-05
R18	6.2K	Carb. Comp	1/2W, 5%	Speer	RC20GF622J	802-622-05
R20	5.6K	Carb. Comp	1/2W, 5%	Speer	RC20GF562J	802-562-05
R23	15 ohm	Carb. Comp	1/2W, 5%	Speer	RC20GF150J	802-150-05
R24,25	10 ohm	Potentiometer		Bourns	3059Y-10	819-100-30
R28	200	Carb. Comp	1/2W, 5%	Speer	RC20GF201J	802-201-05
O1,Q2		Diff. Amp. PNP		National	2N3810	841-381-0X
O3		Silicon NPN		Fairchild	2N3567	835-356-7X
O4		Silicon PNP		Fairchild	2N3638	834-363-8X
O5,O6		Silicon NPN		RCA	2N3440	837-344-0X
O7		Silicon PNP		Motorola	2N4236	836-423-6X
J1		12 pin socket		Cinch-Jones	S312AB	856-312-S1
P1 (not normally supplied)		12 pin plug		Cinch-Jones	P312CCT	856-312-P1
Chassis Rack-Mounting Slide (not normally supplied)		Zener Diode	12V	Zero Mfg.	CTN-120	105-120-TN
CR5		Diode		Motorola	1N5242B	843-524-2X
CR6-13		Diode		ITT	1N4004	845-400-4X
L1	150 uH	Choke		Nytronics	SWD150	851-150-01

CHASSIS ASSEMBLY MODEL 251 ASSEMBLY NO. 620-200-4X

SCHEMATIC DESIGNATION	VALUE	DESCRIPTION OR TYPE	RATING	MANUFACTURER		ELGAR PART NUMBER
				NAME	PART NUMBER	
B1		Fan	25A	Pamotor	4500	853-450-01
BR1		Full Wave Bridge	50V	Motorola	MDA990-3	847-990-3X
C12,C13	15,600 uF	Alum. Elect.	1KV, 10%	G.E.	86F169M	826-153-11
C14	.015 uF	Cer. Disc	10A, 250V	Centralab	DDM153	821-153-10
CB1		Circuit Breaker		Airpax	UPG-111-1-6-1-103	852-103-51
DS1-DS3		Indicator Lamp		Eidema	BG02-RS-A1C-68K	854-68K-22
M1		Output Voltmeter	35, 150, 300V	Jewell	90-282-90	857-282-1T
R1	0-10K	Wire Wound	5%	Spectrol	534-9561-10	819-103-53
R2,R3	4.7K	Carb. Comp.	2W, 5%	Speer	RC42GF472J	804-472-05
R41,43	.1 ohm	Wire Wound	10W, 5%	Dale	CW10-1	808-0R1-05
R42	4.7 ohm	Carb. Comp	½W, 5%	Speer	RC20GF4R7J	802-4R7-05
T1		Input Pwr. Xfmr.		Elgar		990-273-9X
T2		Output Xfmr.		Elgar		990-272-9X
T3		Current Xfmr.		Elgar		990-191-9X
Volts Select Board		PC Plug-in Board		Elgar		620-100-4X
UPPER HEATSINK ASSEMBLY, P/N 620-208-4X						
CR14		Diode		Westinghouse	368D	845-368-DX
Q8-Q12		Silicon NPN		RCA	2N4348	841-434-8X
R31	5.6 ohm	Wire Wound	5W, 5%	Dale	CW5-5.6	807-56R-05
R32-R35	.22 ohm	Wire Wound	5W, 5%	Dale	CW5-22	807-R22-05
S1		Close on rise		Elmwood	3400	861-340-0X
LOWER HEATSINK ASSEMBLY, P/N 620-209-4X						
CR15		Diode		Westinghouse	368D	845-369-DX
Q13-Q17		Silicon NPN		RCA	2N4348	841-434-8X
R36	5.6 ohm	Wire Wound	5W, 5%	Dale	CW5-5.6	807-56R-05
R37-R40	.22 ohm	Wire Wound	5W, 5%	Dale	CW5-22	807-R22-05

CHASSIS ASSEMBLY MODEL 501A, ASSEMBLY NO. 608-229-4X

SCHEMATIC DESIGNATION	VALUE	DESCRIPTION OR TYPE	RATING	MANUFACTURER		ELGAR PART NUMBER
				NAME	PART NUMBER	
B1		Fan		Pamotor	7500	853-750-01
CB1		Circuit Breaker	18A, 250V	Airpax	UPG-1-1-6-1-183	832-183-51
C12-C15	9300 uF	Alum. Elect.	50V	G.E.	86F168M	826-983-12
C18-C23	.05 uF	Kraft Mylar	600V	Sprague	6PS-S50	822-503-06
CR1,3,6		Silicon Diode	40A, 200V	I.R.	1N1186AR	845-118-6R
CR2,4,5		Silicon Diode	40A, 200V	I.R.	1N1186A	845-118-6A
DS1		Power Ind. Lamp		Eldema	BF02-RS-A1C-68K	854-68K-22
M1		Output Voltmeter	0-150VAC	Jewell	MS1T	857-150-1T
R1	0-10K	Wire Wound	5%	Spectrol	534-9561-10	819-103-53
R2,R3	4.7K	Carb. Comp	2W, 5%	Speer	RC42GF472J	802-470-05
R49	4.7 ohms	Carb. Comp	1/2W, 5%	Speer	RC20GF4R7J	802-4R7-05
R50	.05 ohm	Wire Wound	50W, 5%	Dale	RH50-.05	810-R05-05
T1		Input Pwr. Xfmr.		Elgar		990-047-9X
T2		Output Xfmr.		Elgar		990-288-9X
T3		Current Xfmr.		Elgar		990-191-9X
UPPER HEATSINK ASSEMBLY, P/N 608-288-4X						
C16	.022 uF	Paper	200V, 10%	Sprague	192P22392	822-223-05
CR5		Silicon		Westinghouse	368D	845-368-DX
Q8-Q15		NPN		RCA	2N4348	841-434-8X
R31	5.6 ohms	Wire Wound	5W, 5%	Dale	CW5-5.6	807-5R6-05
R32-R38	.22 ohms	Wire Wound	5W, 5%	Dale	CW5-.22	807-R22-05
R39	22 ohms	Carb. Comp	1/2W, 5%	Speer	RC20GF220J	802-220-05
S1		Close on rise		Elmwood	3400	861-340-0X
LOWER HEATSINK ASSEMBLY, P/N 608-229-4X						
C17	.022 uF	Paper	200V, 10%	Sprague	192P22392	822-223-05
CR6	S	Silicon		Westinghouse	368D	845-368-DX
Q16-Q23		Silicon NPN		RCA	2N4348	841-434-8X
R40	5.6 ohms	Wire Wound	5W, 5%	Dale	CW5-5.6	807-5R6-05
R41-R47	.22 ohms	Wire Wound	5W, 5%	Dale	CW5-.22	807-R22-05
R48	22 ohms	Carb. Comp	1/2W, 5%	Speer	RC20GF220J	802-220-05

**SECTION VII
DIAGRAMS****7-1. INTRODUCTION**

7-2. This section contains schematic diagrams and assembly parts layout diagrams for Models 251 and 501A. The schematic diagrams should be used to understand the theory of operation as an aid in troubleshooting the unit. Reference designators shown on schematic diagrams correspond to the reference designators listed in the parts list where exact component values are given.

7-3. DIAGRAMS

7-4. The diagrams included in this section are as follows:

Figure 7-1 – Model 251 Overall Schematic
Drawing No. 520-101-6X

Figure 7-2 – Model 501A Overall Schematic
Drawing No. 505-002-6X

Figure 7-3 – Models 251 & 501A Amplifier Board
Assy. Parts Layout 620-210-XX

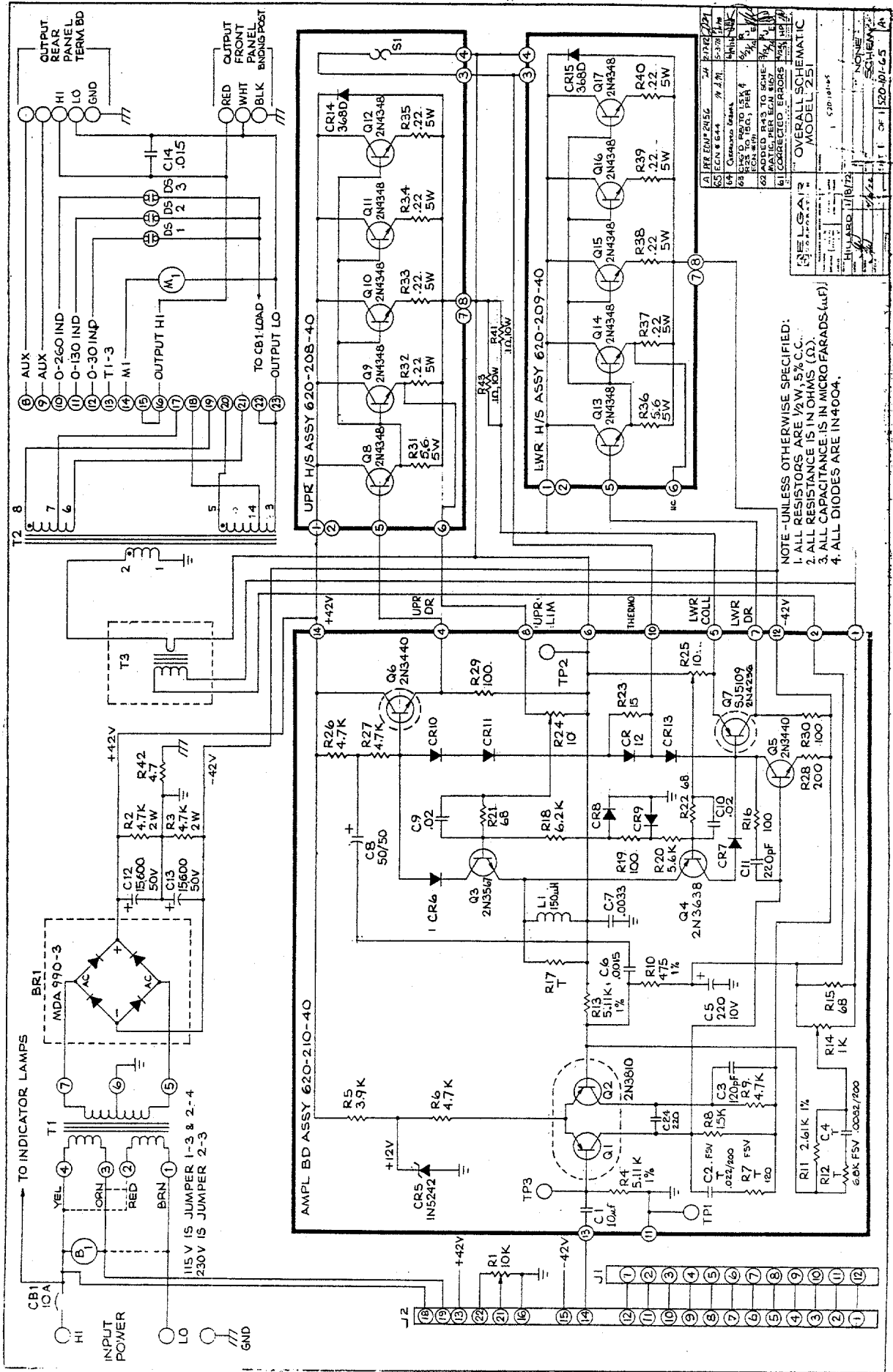

Figure 7-1. Model 251 Overall Schematic, Dwg. No. 520-101-6X

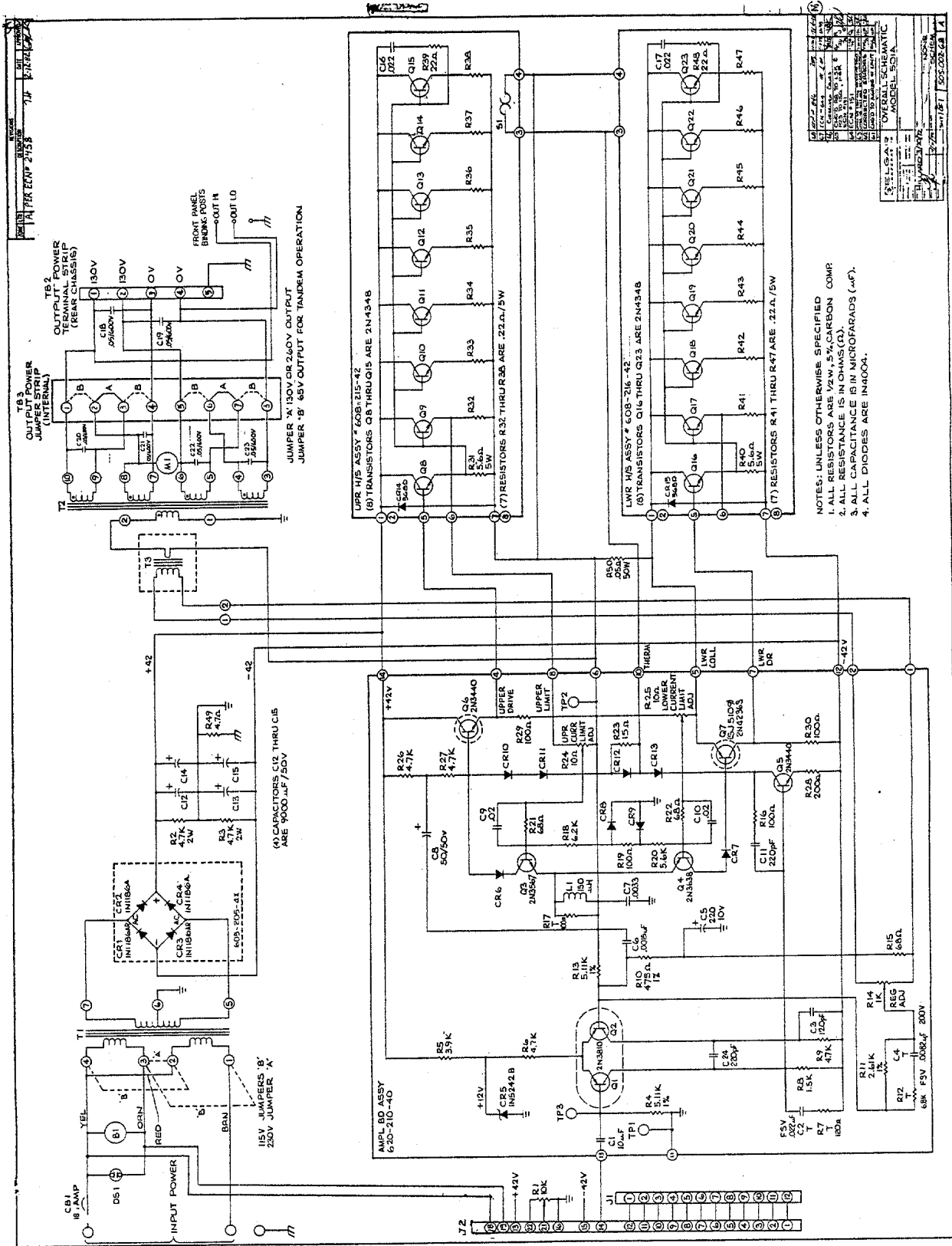

Figure 7-2. Model 501A Overall Schematic, Dwg. No. 505-002-6X



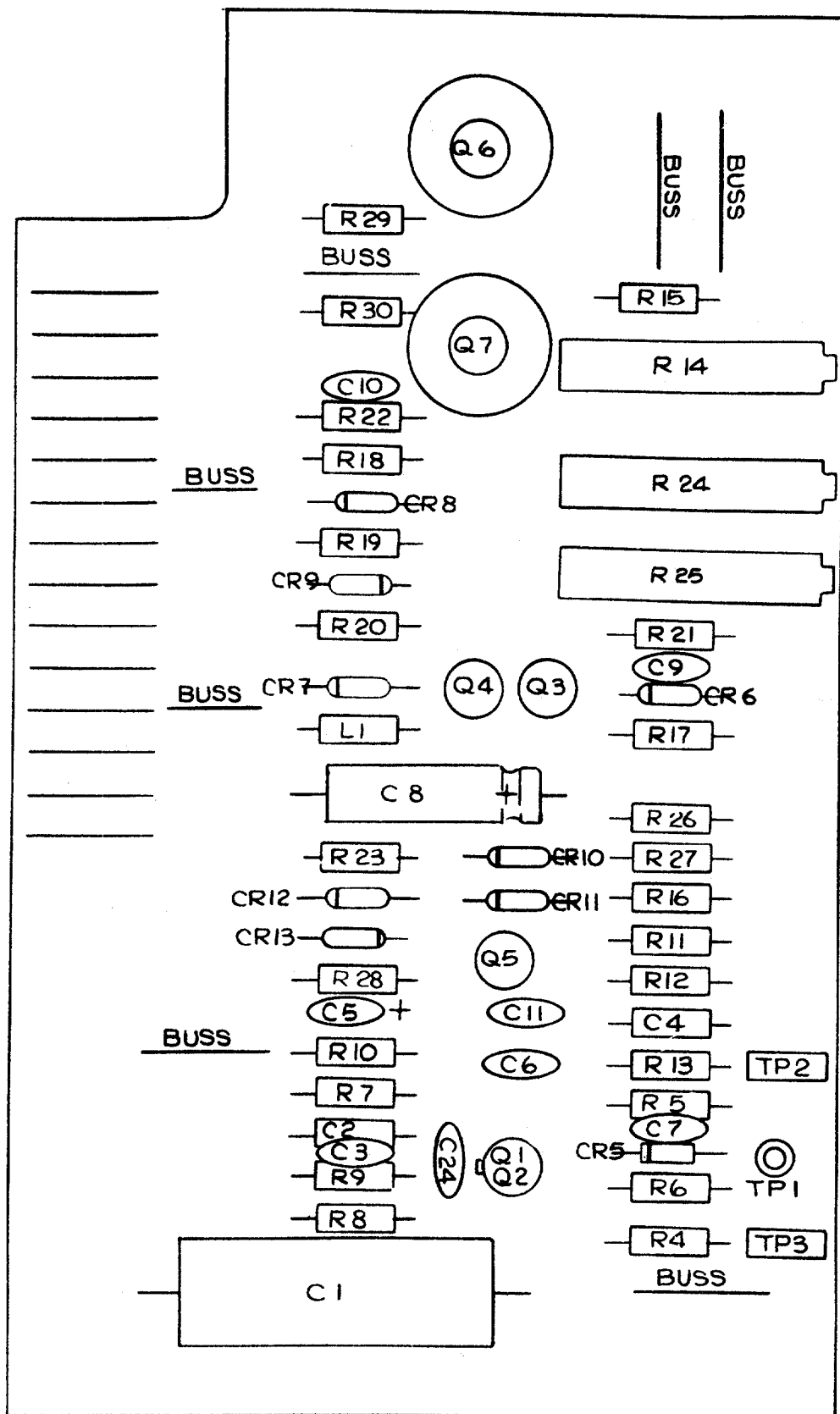

Figure 7-3. Models 251 and 501A Amplifier Board Assembly Parts Layout, Dwg. No. 620-210-00

